

Section 7 Components/ Custom Compatible

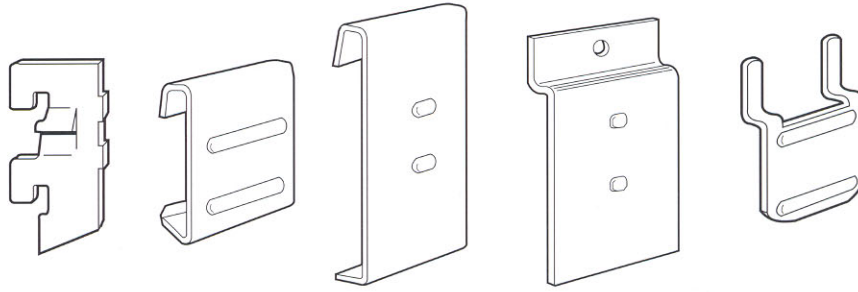

COMPONENTS



CUSTOM MANUFACTURING

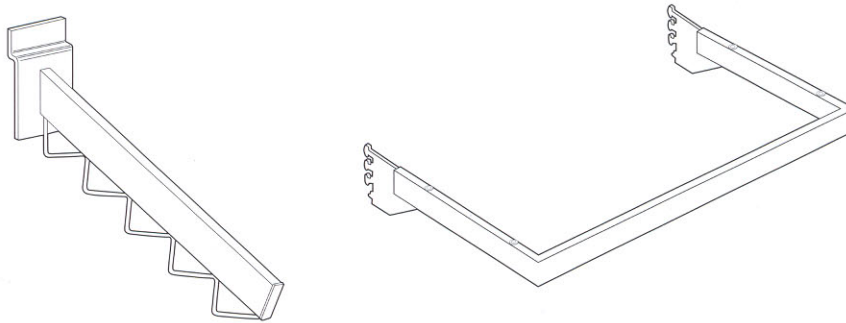

No. C91-271 Peg/Slatwall Plate

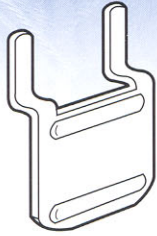

Application:
Fits both pegboard and slatwall.
Features:
Weld projections.
Stock Finish:
Raw.

Part Number
C 91-271

No. C399 Wire Grid Plate

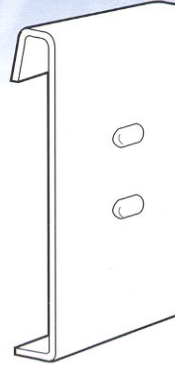

Application:
Use with most grid accessories that use 3" on center mounting.
Features:
Weld projections.
Stock Finish:
Raw.

Part Number	Length
C399-1	1" wide
C399-2	2" wide
C397-2	2" wide w/o dimples

No. C271 Peg Hook Plate

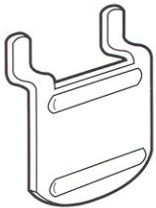

Application:
Use on pegboard.
Features:
Weld projections.
Stock Finish:
Raw.

Part Number
C271

No. C1225-C-C Flat Bar Plate



Application:
Use with 3/16" x 1" flat bar.
Features:
Weld projections.
Stock Finish:
Raw.

Part Number
C1225-C-C
C1225-C-L
C1225-C-R

* Also available without weld projections. Refer to part number C1224-C-WD.

No. C1225-1 Bracket Stub

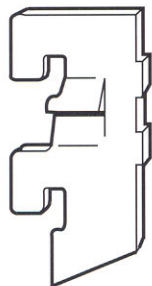

Application:
Fits surface mounted standards with universal slotting.
Stock Finish:
Raw.

Part Number
C1225-1

No. C7370-71 Bracket Stub

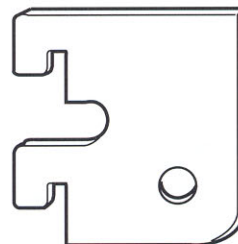

Application:
Fit universal slotting.
Stock Finish:
Raw.

Part Number
C7370-71

All items can be made-to-order in a wide variety of plated or powder coated finishes.

No. C7GA Hook Wire



* Also available with 90° tip.

 7-gauge wire hook.

Application:
Use for welding to saddle, pegboard, slatwall, or grid back plate.
Stock Finish:
Raw.

Part Number	Size
C7GA-2	2"
C7GA-4	4"
C7GA-6	6"
C7GA-8	8"
C7GA-10	10"
C7GA-12	12"

No. C3GA Hook Wire

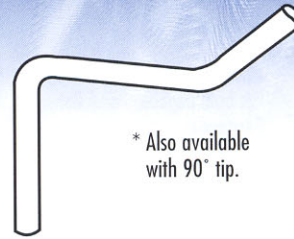

* Also available with 90° tip.

 3-gauge wire hook.

Application:
Use for welding to saddle, pegboard, slatwall, or grid back plate.
Stock Finish:
Raw.

Part Number	Size
C3GA-2	2"
C3GA-4	4"
C3GA-6	6"
C3GA-8	8"
C3GA-10	10"
C3GA-12	12"

No. C725-UNP Saddle

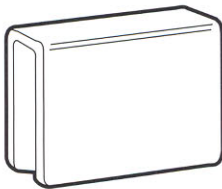

Part Number

C725

Application:
Use for faceout or hangrod bracket. Fits 1/2" x 1 1/4" and 1 1/2" hangbar.
Features:
3/16" thick steel.
Stock Finish:
Raw.

No. C742-4 Bracket Stub

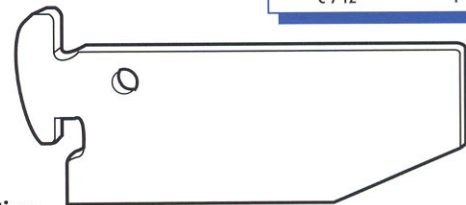

Part Number **Size**

C-742 4"

Application:
Use as stub for faceouts and welded U-frames.
Features:
11-gauge tempered steel.
Stock Finish:
Raw.

C98-BP Slatwall Weld Plate

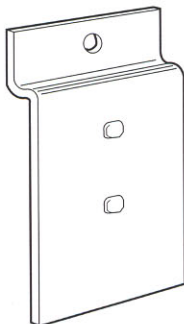

Part Number **Width**

C98-BP 2"

C99-BP 1"

C97 2" w/o dimples

Application:
Weld to bracket or hook.
Features:
Weld projections.
Stock Finish:
Raw.

No. C-98 Bracket Weld Blank

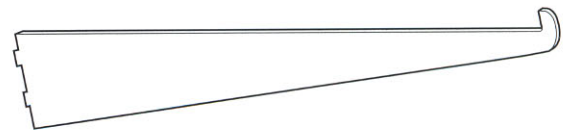

Part Number **Size**

C98-12 12"

Application:
Weld to slatwall, gridwall plate, saddle, or pegboard plate.
Features:
Weld projections. Tempered steel.
Stock Finish:
Raw.

All items can be made-to-order in a wide variety of plated or powder coated finishes.

C725-4 Stub

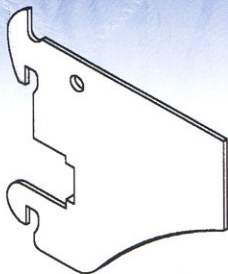

Application:
3 $\frac{3}{8}$ " wide at standard. Fits all 700 series standards.
Stock Finish:
Raw.

C22078-4 Bracket Stub

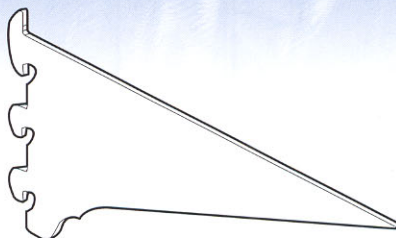

Application:
2 $\frac{1}{8}$ " wide at standard. Fits Reewall standards.
Stock Finish:
Raw.

C680-4 Bracket Stub

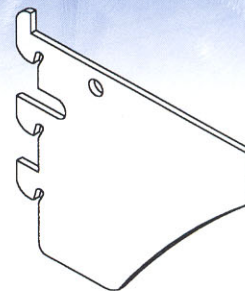

Application:
Fits Universal slotted standards.
Stock Finish:
Raw.

C30000-12 Bracket

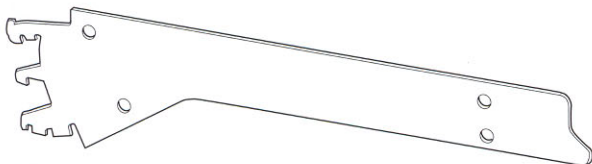

Application:
12" shelf bracket (other sizes available).
Fits Reewall wall system.
Stock Finish:
Raw.

C30200-12 Bracket

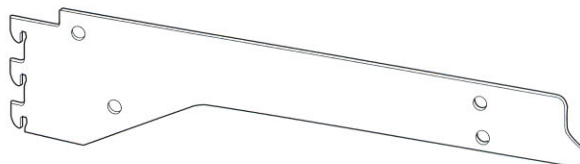

Application:
12" shelf bracket (other sizes available).
Fits Reewall wall system.
Stock Finish:
Raw.

C824-SB Bracket Stub

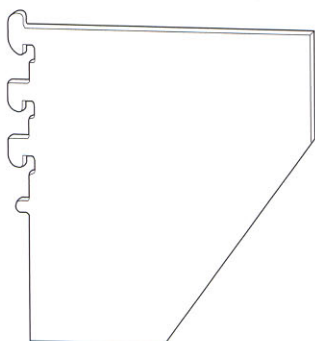

Application:
5 $\frac{1}{2}$ " wide at standard. Fits 800 series standards.
Stock Finish:
Raw.

C825-4 Bracket Stub

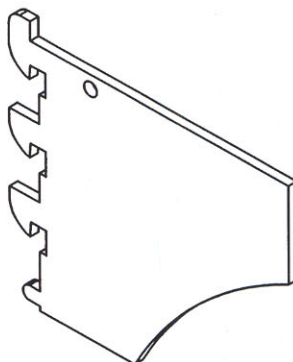

Application:
3 $\frac{1}{2}$ " wide at standard. Fits 800 series standards.
Stock Finish:
Raw.

C278-3-C Prong Clip

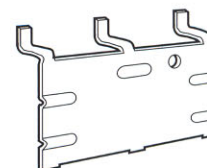

Application:
2 $\frac{1}{4}$ " wide. Fits peg board.
Stock Finish:
Raw.

All items can be made-to-order in a wide variety of plated or powder coated finishes.

C138 Plate

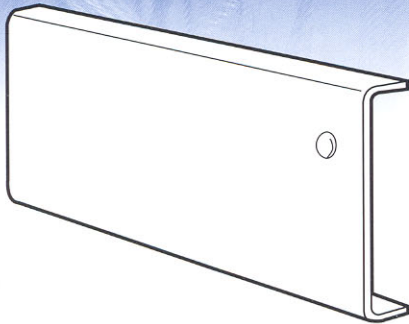

Application:
1 1/4" I.D. x 2 1/8" long.
Stock Finish:
Raw.

C800-KC Clip

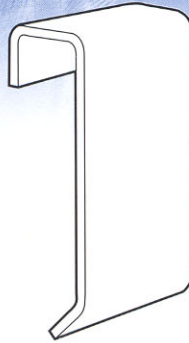

Application:
Fits 1/2" x 1 1/2" Hangrod.
Stock Finish:
Raw.

C1250 Base

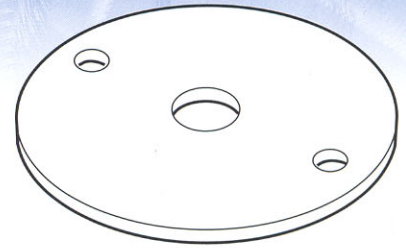

Application:
3 1/8" diameter. Mounting holes 2 1/2" on center.
Stock Finish:
Raw.

C7366-P Plate

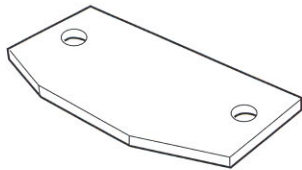

Application:
3" x 1 1/4" plate. Two mounting holes.
Stock Finish:
Raw.

C70-P Facia Plate

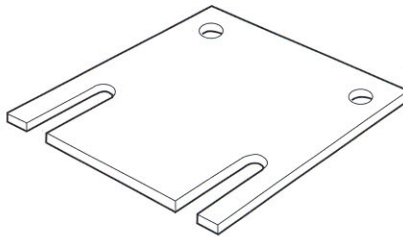

Application:
3" x 3" mounting plate.
Stock Finish:
Raw.

C7351 Clip

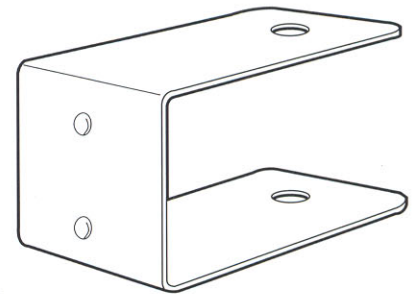

Application:
1 1/4" x 1 1/2" Saddle clip.
Stock Finish:
Raw.

C6215-P Plate

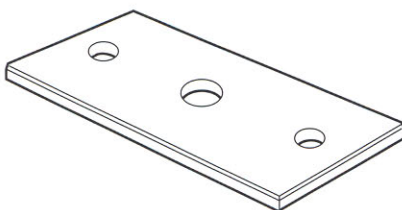

Application:
1 1/4" x 3" x 1/8" thick.
Stock Finish:
Raw.

C6631-P Plate

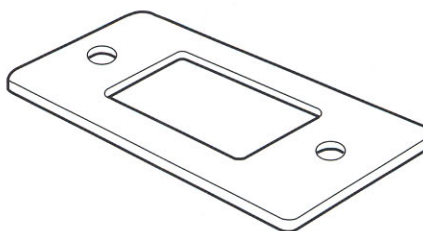

Application:
2" x 4 1/4" plate. 1/8" thick.
Mounting holes 3 1/2" on center.
Stock Finish:
Raw.

C83-63-U Bracket Stub

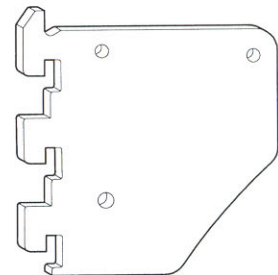

Application:
Fits Universal slotted standards.
Stock Finish:
Raw.

All items can be made-to-order in a wide variety of plated or powder coated finishes.

Components

C1813 Clip

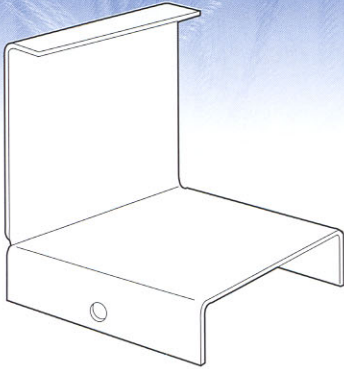

Application:
End Frame clip. Fits 2" tube.
Stock Finish:
Raw.

C456-D&M Plate

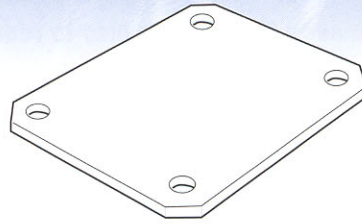

Application:
3" x 4" x 1/8" thick with four 3/16" mounting holes.
Stock Finish:
Raw.

C202-R Piece Goods Rib

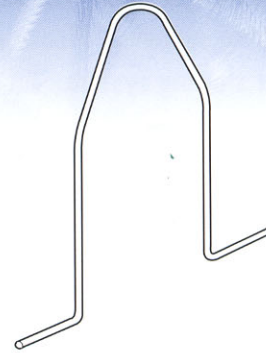

Application:
1/4" diameter wire. 9" high.
Stock Finish:
Raw.

C236-Rod

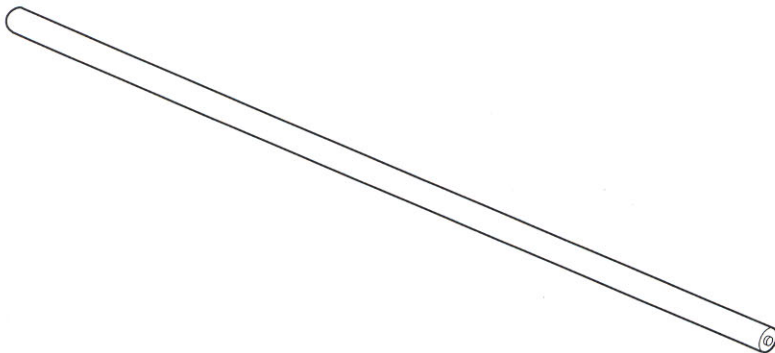

Application:
3/8" x 12" rod.
Stock Finish:
Raw.

C3-3 Stainless Steel Channel

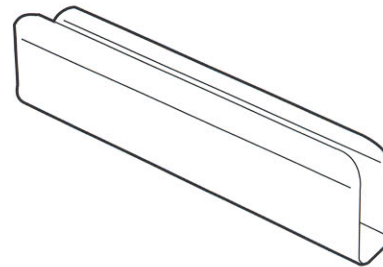

Application:
Fits 3" Binning Glass.

C3/8-Cube

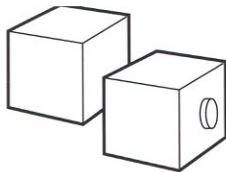

Application:
3/8" square welding cube.
Stock Finish:
Raw.

C7340-C Connector Channel

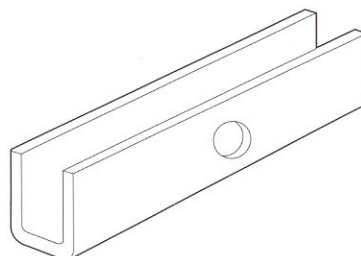

Application:
3/4" x 1/8" O.D. x 1/8" thick.
Stock Finish:
Raw.

C745-C-U Clip

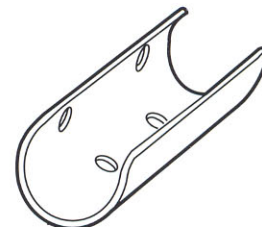

Application:
Hangrod saddle spring clip. Fits 1 1/16" hangrod.
Stock Finish:
Raw.

All items can be made-to-order in a wide variety of plated or powder coated finishes.

Reeve Store Equipment Co. has the capability to build custom brackets, faceouts, and displayers that fit varied slotting systems. Please contact Customer Service to request a stub bracket sample chain to see if we can fit your slotting system. All stubs are available with stabilizer pins to reduce sway.

No. **(L)** Stub Bracket
(L & M)

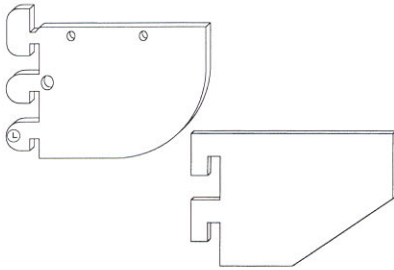

Fits $\frac{3}{4}$ " long slot at 1" on center.
 $\frac{3}{16}$ " (.187") thick standard/upright.

No. **(Y)** Stub Bracket
(D & Sy)

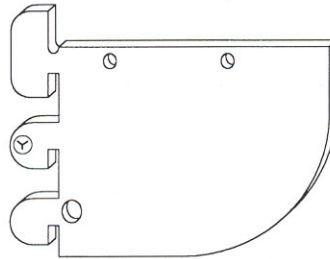

Fits $\frac{3}{4}$ " long slot at 1" on center.
 $\frac{1}{8}$ " (.125") thick standard/upright.

No. **(M)** Stub Bracket
(Mg & St)

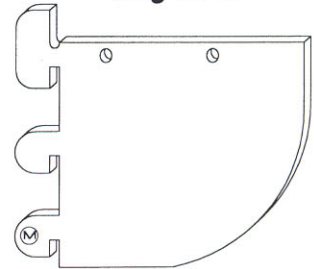

Fits $\frac{7}{8}$ " long slot at 1 $\frac{1}{4}$ " on center.
 $\frac{1}{8}$ " (.125") thick standard/upright.

Below is a variety of brackets, faceouts, and custom displayers available with the Custom Compatible stub brackets...

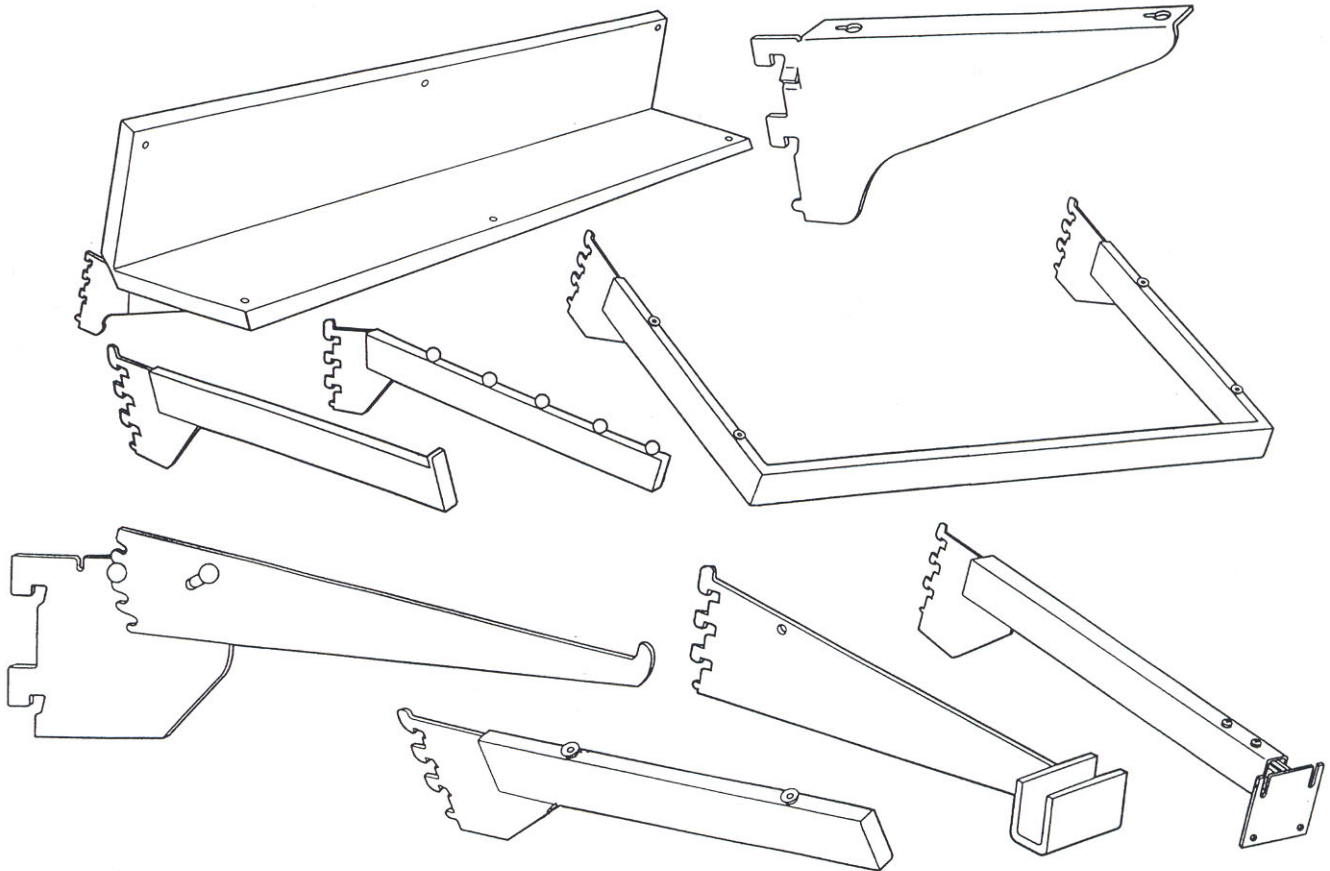

All items can be made-to-order in a wide variety of plated or powder coated finishes and/or custom lengths.

This system is based on a $\frac{5}{8}$ " long slot at 1" on center with a .090" thick standard/upright. It is fully compatible with the Sears and Meg (MPDS) systems. A variety of standards, brackets, faceouts, and custom displayers can be made-to-order. In addition, a REEWALL gondola can be made-to-order utilizing Reeve stock gondola components combined with the REEWALL standard and shelves. Please contact Customer Service or your Reeve Regional Sales Representative for more information.

No. 30801- $\frac{1}{4}$ " x 2" Tubing Standard

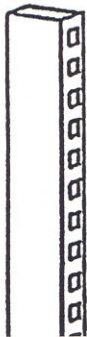

* Wide slot fits two brackets or shelves side-by-side.

Part Number	Length
3080	1' to 10'

No. 3044 Standard

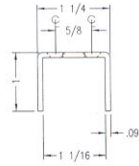

* Wide slot fits two brackets or shelves side-by-side.

Part Number	Length
3044	1' to 10'

No. 17519 Standard



Part Number	Length
175199	1' to 10'

No. 22078 Shelf Bracket

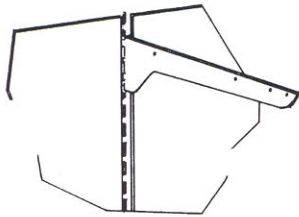

Part Number	Length
22078	8" to 24"

No. 22256 Shelf Bracket (Adjustable)

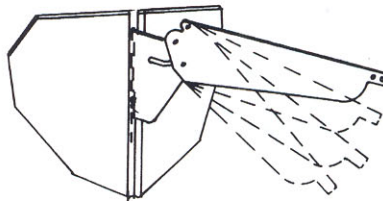

Part Number	Length
22256	8" to 24"

No. 17156 Glass Shelf Bracket

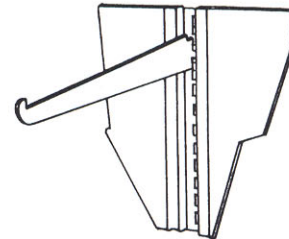

Part Number	Length
17156	8" to 16"

No. 24346 Stub Bracket

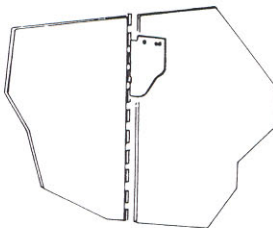

Part Number	Length
24346	2.5"

No. 17084 Cornice Bracket

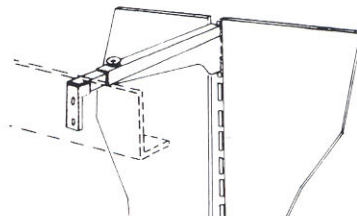

Part Number	Length
17084-1	18" to 27"
17084-2	27" to 36"

No. 17137 Curtain Wall Bracket

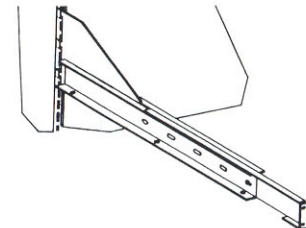

Part Number	Length
17137-1	20" to 26"
17137-2	26" to 35"

All items can be made-to-order in a wide variety of plated or powder coated finishes and/or custom lengths.

Shelf Clips with Grommet

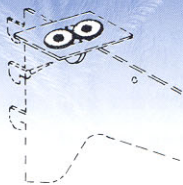

*Left, Right, and Center shelf clips available.

Part Number
17193

No. 17258 Continuous End Rest

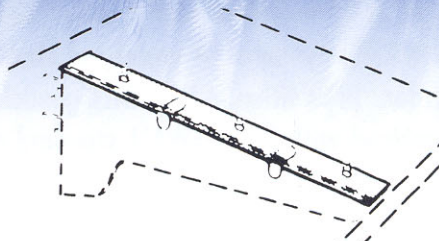

*Left, Right, and Center continuous rests available.

Part Number
17258

No. 17494 Hangrod Connector

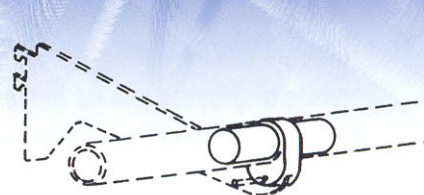

*Left, Right, and Center End Connectors available.

Part Number
17494

REEWALL Shelf (1 Position)

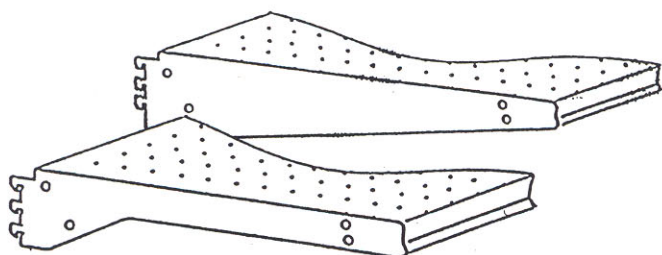

Part Number	Size
3014	14" x 30"/36"/48"
3016	16" x 30"/36"/48"
3018	18" x 30"/36"/48"
3022	22" x 30"/36"/48"

REEWALL Shelf (4 Position)

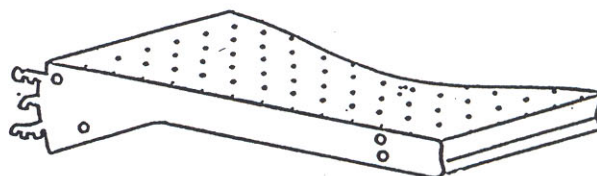

Part Number	Size
3008	8" x 30"/36"/48"
3010	10" x 30"/36"/48"
3012	12" x 30"/36"/48"

REEWALL Faceout and Hangrod Brackets

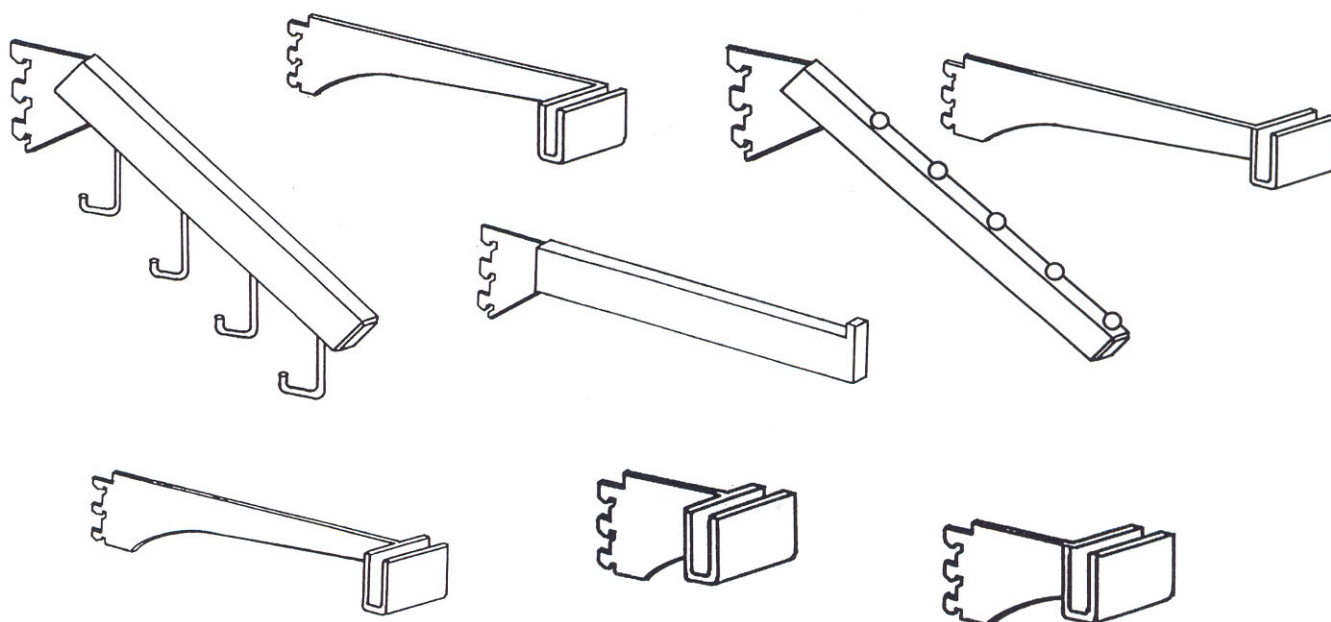

All items can be made-to-order in a wide variety of plated or powder coated finishes and/or custom lengths.